

# Theory of Operations

The collage illustrates the theory of operations for Airmar transducers. It includes several key components and data points:

- Sonar Scan:** A diagram showing a boat's sonar system emitting a conical beam to detect fish underwater.
- Fish Head:** A detailed illustration of a fish's head, highlighting its eye and mouth.
- Transducer Cross-Section:** A diagram of a transducer showing a central cable and an outer housing.
- Transducer Cable:** A diagram of an "AIRMAR TRANSDUCER CABLE #C1 30000" showing its internal structure, including a jacket, shield, and conductor.
- dB vs. Frequency Graph:** A graph showing the relationship between decibels (dB) and frequency. The y-axis ranges from 140 to 165 dB, and the x-axis shows a bandwidth of 5.2 kHz. A 5 dB slope is indicated.
- Hearing Range Comparison:** A bar chart comparing the hearing frequency ranges for fish, humans, and Airmar transducers. The y-axis is logarithmic, ranging from 0 to 10 MHz.

Entity	Frequency Range
Fish hearing frequency range	10 Hz to 10 kHz
Human hearing frequency range	20 Hz to 20 kHz
Airmar transducers frequency range	10 kHz to 1.5 MHz

# Contents

<b>I. Introduction</b>	<b>1</b>
<b>A. Airmar Technology Corporation</b>	<b>2</b>
<b>B. Echosounder Systems</b>	<b>3</b>
<b>C. Transducers</b>	<b>3</b>
<b>D. Frequencies</b>	<b>5</b>
<b>E. Piezoceramic Elements</b>	<b>7</b>
<b>F. Sound Waves</b>	<b>9</b>
<b>G. The Structure of Transducers</b>	<b>11</b>
<b>H. Performance Testing</b>	<b>13</b>
<b>I. Airmar Products</b>	<b>16</b>
<b>J. Glossary of Terms</b>	<b>19</b>

# Theory of Operations

**T**he purpose of this booklet is to inform you about the products that are designed and manufactured by Airmar and give you a basic understanding of how they work and how they are used. Our customers depend upon us for products that meet their requirements. As a member of the Airmar Team, your quality work is a vital part of meeting those requirements and contributes to maintaining Airmar's leadership position in the transducer industry.

The information in this booklet will help you to better understand how significant what you do is, and how it fits into the overall picture. Included is a glossary of frequently used scientific terminology. If you have any questions not answered by this booklet, please submit them to your manager.

## Airmar Technology Corporation

### What is Airmar?

Airmar Technology Corporation was founded in Amherst, New Hampshire in 1982 by two engineers, Stephen G. Boucher and Robert K. Jeffers. Airmar moved to Milford in 1987 where it continues to grow as a leader in the transducer industry.

At Airmar, we pride ourselves on our ability to work hand-in-hand with our customers to fulfill their specific requirements with the highest quality products. This may be done with one of our existing products, a slight modification to a standard product, or an entirely new design.

Airmar's first product in 1982 was a simple, marine, ultrasonic transducer. Today, marine transducers remain the core of our product line with over 1,000 transducer part numbers available. We now offer:

- Recreational sensors for echosounders, fishfinders, and personal watercraft
- Commercial fishing transducers for vessels of all sizes
- Large navigation and survey transducers for use on ships and research vessels
- Aquaculture systems
- Air transducers for industrial uses

Airmar holds over twenty-five United States and foreign patents. We have won the important Innovation Award presented by the International Marine Trade Exhibition Conference for the first truly low-cost phased array transducer developed for use in marine environments. This transducer allows electronic steering of the ultrasonic beam giving the user the ability to gather more information.

Designers, engineers, and scientists develop the products. Assemblers on the manufacturing floor produce the sensors and a full line of parts and accessories. All this activity is supported by shippers, receivers, maintenance people, and business personnel.

### Who are Airmar's customers?

Airmar has a world-wide customer base of Original Equipment Manufacturers (OEMs). Our sensors are bought to be coupled with the OEM's electronics. Usually, the OEM sells the system to the public with its name on the label.

While many of our customers are echosounder producers, we have customers in other industries as mentioned earlier. Some of our customers include:

- Raytheon
- Furuno
- Yamaha
- Odom
- Hycontrol
- Lowrance
- Standard Communications
- Interphase
- Kawasaki
- Bombardier

We also sell to one after-market distributor, Gemeco. This company sells replacement transducers as well as marine accessories to the public.

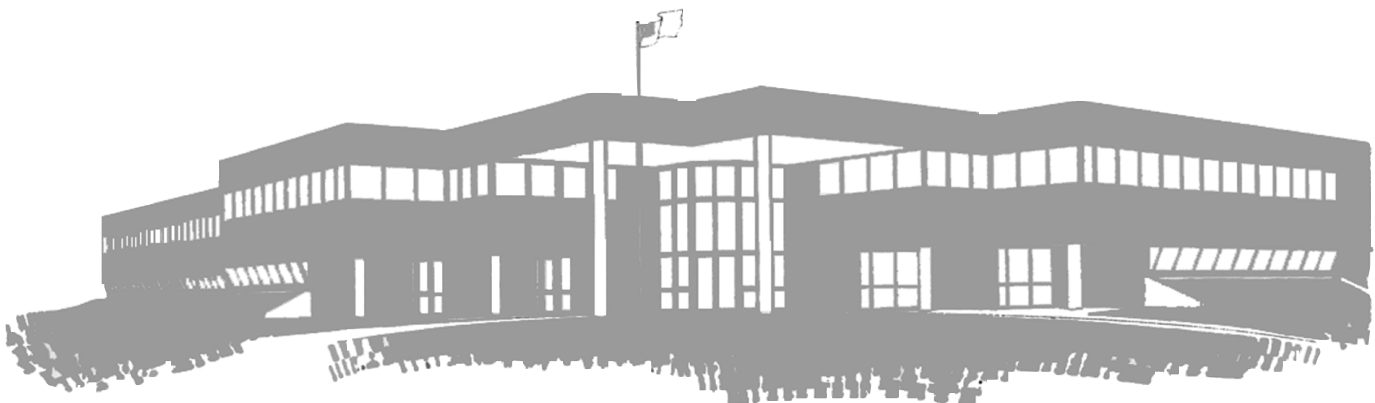

## Echosounder Systems

### What is an echosounder system?

An echosounder system is specialized equipment which gives a boater or fisher the ability to see below the surface of the water. It gives information about the depth and shape of the bottom and of any fish present.

An echosounder system is made up of two major parts. The first is the echosounder. This includes a display screen to present the information, the transceiver to drive the transducer and receive echo information, and a microcomputer to process the information.

The second key part is the transducer. It generates sound waves and receives the echoes of those sound waves. The information is fed from the transducer through cables to the echosounder which interprets and presents the information in an understandable form on the display screen.

### How does an echosounder system work?

All echosounder systems work in essentially the same way. The echosounder

transceiver generates high voltage electrical pulses and sends them to the transducer. The transducer converts these pulses into sound waves that bounce off objects underneath the boat, then echo back to the transducer. The transducer converts the sound energy of the echo to an electrical pulse which is returned to the echosounder. The echosounder measures the time between the beginning of a pulse of sound and the return of the echo. The microprocessor then “reads” this information, translates it, and presents it on a display screen in a way that depicts the bottom, any objects, and the location of any fish.

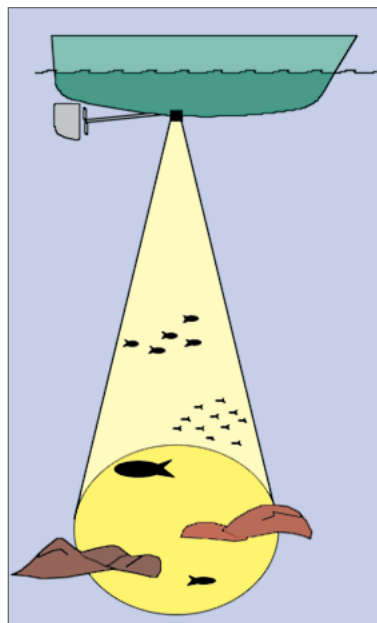

Different echosounders display information in different ways. A flasher type echosounder displays illuminated bars of varying intensity to depict the depth of the water and any objects in the water. A digital echosounder displays the bottom depth in numbers or letters. Echosounders with LCD and CRT screens display the information in a “picture” form.

### What part of the echosounder system does Airmar produce?

Airmar produces the transducer—the underwater sensor for the echosounder system.

## Transducers

### What is a transducer?

The transducer is the heart of an echosounder system. It is the device that changes electrical pulses into sound waves or acoustic energy and back again. In other words, it is the device that sends out the sound waves and then receives the echoes, so the echosounder can interpret or “read” what is below the surface of the water.

### How does a transducer work?

The easiest way to understand how a transducer functions is to think of it as a speaker and a microphone built into one unit. A transducer receives sequences of high voltage electrical pulses called transmit pulses from the echosounder. Just like the stereo speakers at home, the trans-

ducer then converts the transmit pulses into sound. The sound travels through the water as pressure waves. When a wave strikes an object like a weed, a rock, a fish, or the bottom, the wave bounces back. The wave is said to echo—just as your voice will echo off a canyon wall.

When the wave of sound bounces back, the transducer acts as a microphone. It receives the sound wave during the time between each transmit pulse and converts it back into electrical energy. A transducer will spend about 1% of its time transmitting and 99% of its time quietly listening for echoes. Remember, however, that these periods of time are measured in microseconds, so the time between pulses is very short.

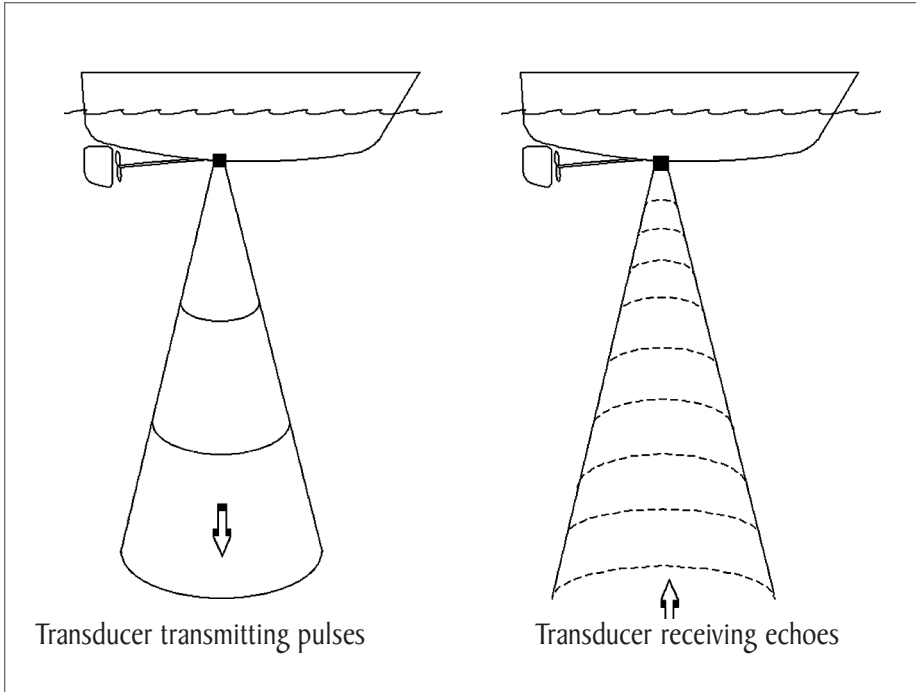

## How does a transducer know what the bottom looks like?

As the boat moves through the water, the echoes of some sound waves return more quickly than others. We know that all sound waves travel at the same speed. When a sound wave in one section of the sound field returns more quickly than another, it is because the wave has bounced off something closer to the transducer. These early returning sound waves reveal all the humps and bumps in the underwater surface. Transducers are able to detect whether a bottom is soft or hard and even distinguish between a

The echosounder can calculate the time difference between a transmit pulse and the return echo and then display this information on the screen in a way that can be easily understood by the user.

clump of weeds and a rock, because the sound waves will echo off of these surfaces in a slightly different manner.

## How does a transducer know how deep the water is?

The echosounder measures the time between transmitting the sound and receiving its echo. Sound travels through the water at about 4,800 feet per second, just less than a mile per second. To calculate the distance to the object, the echosounder multiplies the time elapsed between the sound transmission and the received echo by the speed of sound through water. The echosounder system interprets the result and displays the depth of the water in feet for the user.

## How does a transducer see a fish?

The transducer can see a fish, because it senses the air bladder. Almost every fish has an organ called an air bladder filled with gas that allows the fish to easily adjust to the water pressure at different depths. The amount of gas in the air bladder can be increased or decreased to regulate the buoyancy of the fish.

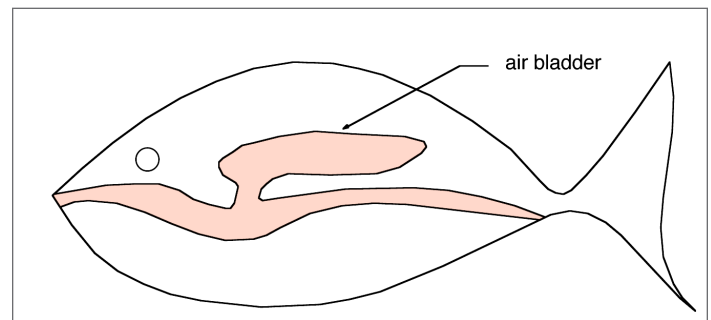
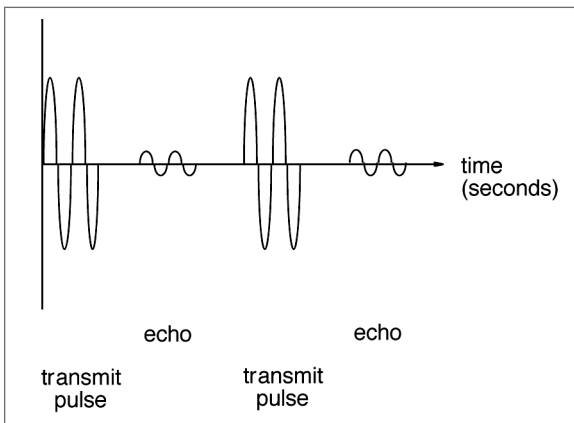

Because the air bladder contains gas, it is a drastically different density than the flesh and bone of the fish as well as the water that surrounds it. This difference in density causes the sound waves from the echosounder to bounce off the fish distinctively. The transducer receives the echoes and the echosounder is able to recognize these differences. The echosounder, then, displays it as a fish.

## Frequencies

### What is frequency?

Frequency is the number of complete cycles or vibrations that occur within a certain period of time, typically one second. Sound waves can vibrate at any one of a wide number of frequencies. The easiest way to understand frequency is to think of it in terms of sounds that are familiar. For example, a kettle drum produces a low-pitched sound (low frequency). That is, it vibrates relatively few times per second. Whereas, a flute produces a high-pitched sound (high frequency). It vibrates many more times per second than a kettle drum.

The frequency of sound waves is measured in a unit called a Hertz. A Hertz is one cycle per second. For example: a 150 kHz transducer operates at 150,000 cycles per second.

### Is the frequency of all transducers the same?

No, transducers can be designed to operate efficiently at any number of specific frequencies depending upon the application and performance requirements of the customer. Airmar transducers are often designed for 50 kHz (50,000 cycles per second) or 200 kHz (200,000 cycles per second).

### Can fish hear the sound waves produced by a transducer?

No, the sound waves are ultrasonic. They are above (ultra) the sound (sonic) that human ears are able to

hear. Humans can hear sound waves from 10 Hz to 20 kHz. Most fish are unable to hear frequencies higher than about 500 Hz to 1 kHz. The ultrasonic sound waves sent out by Airmar transducers have frequencies ranging from 10,000 kHz to 2 Megahertz (200,000,000 Hz), clearly beyond the hearing of fish. However, most people can hear the transmit pulses of our 10 kHz transducers; they sound like a series of clicks.

### How does the frequency of a transducer determine what we see?

A higher frequency transducer will put out quicker, shorter, and more frequent sound waves. Like the ripples made

when a small pebble is thrown into still water, small waves of sound move evenly out and away from the source. Because they are just small waves, they will not travel far and small obstacles will cause them to bounce back. Higher frequencies are more sensitive to small objects and will send back detailed information which will show as crisp, high-resolution pictures on the echosounder screen. The range of high frequency sound waves, however, is short. In fact, sound waves emitted by a 200 kHz transducer have a limited range of about 600 feet.

Now, think of the large waves created by a large boulder thrown into still water. Low frequency sound waves are like these large waves; they travel much farther than high

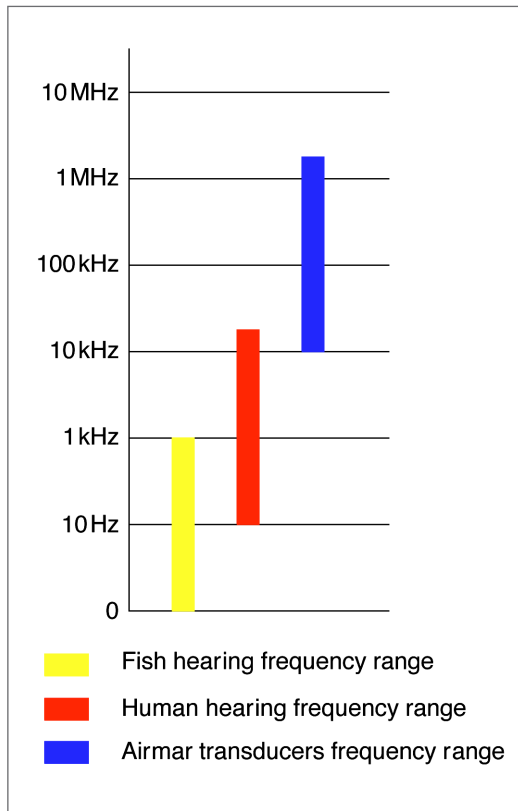

	Higher Frequency	Lower Frequency
<b>Number of waves or cycles per second</b>	more	fewer
<b>Wave length</b>	shorter	longer
<b>Detail</b>	more detail, small objects	less detail, large objects
<b>Depth Capacity</b>	shallow to moderate	deeper

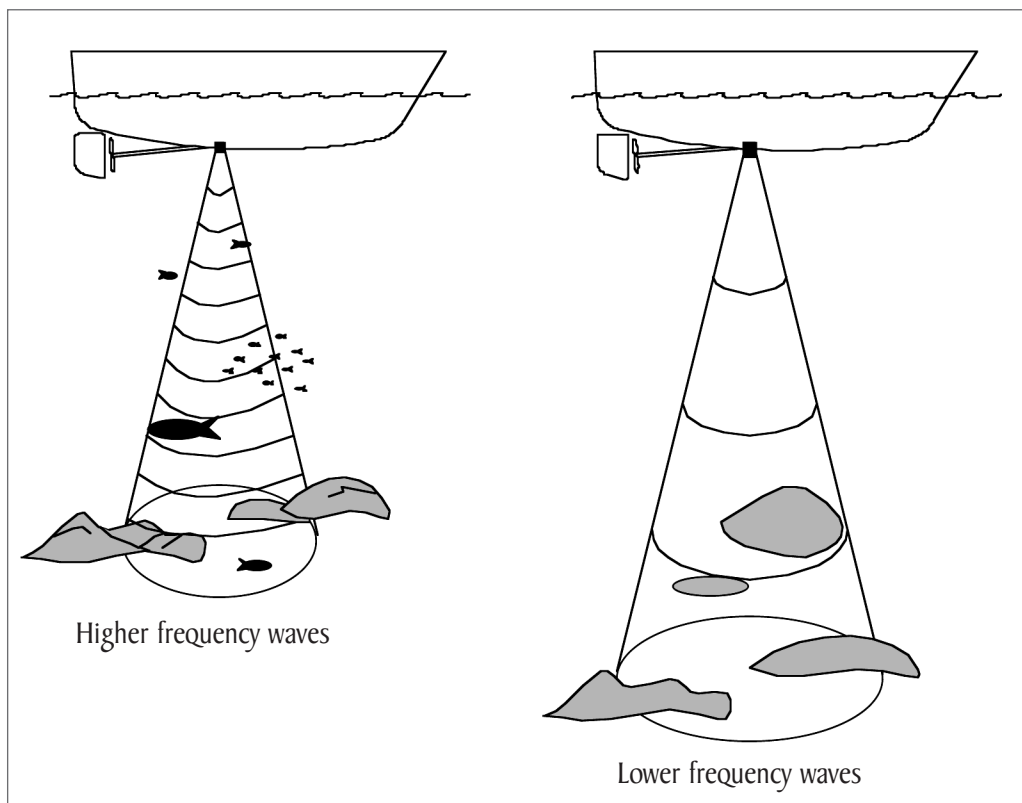

The speed of sound in water is 4,800 feet per second. If we have a 200 kHz transducer then our equation would look like this:

$$4800 \text{ ft/sec} \div 200,000 \text{ cyc/sec} = 0.024 \text{ ft/cyc} = 0.29 \text{ inches/cyc}$$

One sound wave at 200 kHz is slightly longer than 1/4 of an inch, so a 200 kHz sound wave will be able to detect fish as short as a quarter of an inch.

Let us compare the 200 kHz transducer to the size of a wave length of a 50 kHz transducer:

$$4800 \text{ ft/sec} \div 50,000 \text{ cyc/sec} = 0.096 \text{ ft/cyc} = 1.15 \text{ inches/cyc}$$

One sound wave at 50 kHz is slightly over one inch, so a 50

kHz sound wave will only detect fish if their air bladders are large, slightly longer than an inch.

frequency waves. But because low frequency waves are so large, they wash right over small obstacles. Low frequency sound waves are not as sensitive in detecting small fish or other small obstacles as are high frequency waves, and although they can see to greater depths, they will not send back detailed information or clear crisp pictures.

## Why is it important to know the length of a sound wave?

Knowing the length of sound waves is particularly important, because it determines where the sound waves will bounce. A sound wave will bounce strongly off something that is larger than itself. If the object is smaller, then the sound wave will almost wash over the object, and the echo will be very weak.

The length of a sound wave is determined by the frequency of the sound vibrations and the density of the medium that the sound is traveling through. At Airmar, wave length is calculated by dividing the speed of sound in water by the frequency.

## How does a customer decide what frequency is needed?

A higher frequency sound wave will give the user a higher resolution picture of what is present under the water, but the range will be short. Fishers in more shallow lakes who want a crisp clear picture of the bottom need a higher frequency transducer.

Low frequency sound waves will not give the user as clear a picture of the bottom, but they have greater range for very deep areas where high frequency sound waves cannot reach. A low frequency unit will work well in the depths of Lake Michigan or the ocean. You may find the chart on page 5 helpful.

## Piezoceramic Elements

### What are piezoceramic elements?

The main component of a depth transducer is the piezoceramic element. It is the part that converts electrical pulses into sound waves, and when the echoes return, the piezoceramic element converts the sound waves back into electrical energy.

Airmar does not manufacture its own piezoceramic elements, because their manufacture is a very specialized process. Instead, we buy piezoceramics from companies that make them to our specifications.

### What does a piezoceramic element look like?

Piezoceramic elements are most often in a disk form, but they may also be in the shape of a bar or a ring. A transducer may contain one element or a series of elements linked together called an array.

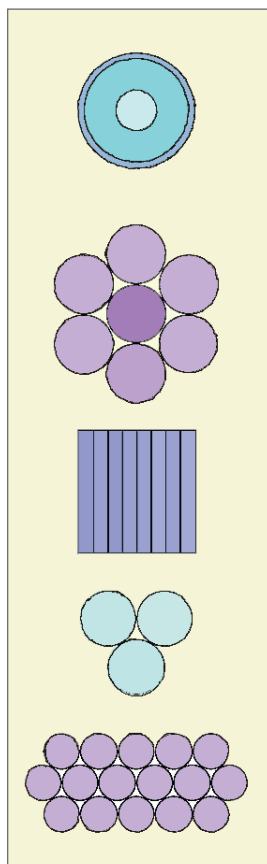

### What are piezoceramic elements made of?

Most of the piezoceramic elements that we use in our transducers are made of Barium Titanate (BT) or Lead Zirconate Titanate (PZT).

### How are piezoceramic elements made?

The BT and PZT elements go through several processes before Airmar receives them.

**Pressing**—Both BT and PZT begin in powdered form. The powder is pressed into the desired shape.

**Firing**—The pressed shapes are baked in a kiln just like we might fire a clay pot made in an art class. The temperature of the kiln depends upon the element's maximum heat tolerance. It is important to fire the piezoceramic at precisely the right temperature.

Like a piece of china that has been fired in a kiln, the piezoceramic element is very strong, yet brittle and easily cracked or broken. Any piezoceramic element that has been cracked or chipped, even slightly, will not function properly in a transducer.

**Coating**—After pressing, the piezoceramic element is coated on two opposite sides with a layer of silver and baked a second time, so the silver actually bakes onto the element. This silver functions as the electrode, the material that will conduct electric current through the element.

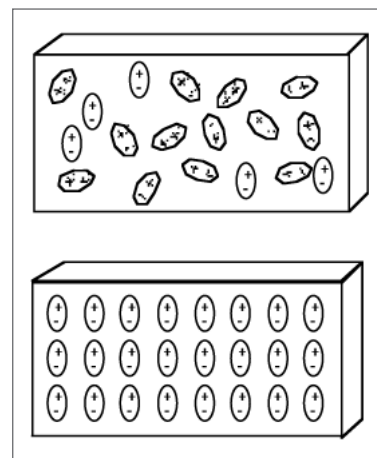

**Polarizing**—Next the piezoceramic element is polarized. Piezoceramic elements are made up of individual crystals that have a positive (+) and negative (-) electric charge on respective ends. These crystals are normally resting in a haphazard way in the piezoceramic element. But if a high voltage electric current is applied to the element, the crystals will adjust their alignment until nearly all are positioned in straight columns with their positive (+) and negative (-) poles lying in the same direction.

Note: Since this process is done in an oil bath, it is very important that the piezoceramic element has all of the oil carefully removed or the potting material will not bond to it. A weak bond will result in poor transducer performance and poor reliability.

### How do piezoceramic elements work?

Remember, transducers work by taking electrical pulses from the echosounder and changing them into sound waves. This process is reversed when the transducer is acted upon by the pressure of the returning echoes which is called transduction.

The internal arrangement of the piezoceramic element's crystals with their positive (+) and negative (-) poles lying

## Theory of Operations

in the same direction is the key factor. Pulses of alternating current (AC) from the echosounder activate the piezoceramic element. The AC changes its direction of flow back and forth. [Which is why it is said to alternate, and this change in the direction of the flow is noted as (+) and (-).] Because the piezoceramic elements are polarized, they will expand when a positive voltage is applied and contract when a negative voltage is applied.

The piezoceramic's expansion and contraction changes the electrical pulse into sound waves that will travel through the water until they bounce off an object or weaken and finally dissipate.

When an echo returns to the transducer, the pressure of the sound waves act on the piezoceramic element causing it first to contract and then to expand as each cycle in the echo hits it. This alternating pressure on the element creates a small voltage which is then sent back to the transceiver and micro-processor.

The element expands and contracts at the frequency of the electrical pulse. This occurs very rapidly, faster than can be seen by the eye. The frequency of the expansion and contraction is controlled by the frequency of the pulse generator in the echosounder.

### How do the engineers know which piezoceramic element to use?

When an electrical voltage is applied to a piezoceramic element, it will vibrate best at a certain frequency. Piezoceramic materials can be thought of as bells. When a bell rings, it produces a tone. Each bell has its own natural resonant frequency. Those who cast bells know the size and shape necessary to create a bell that produces a certain tone.

Like bells, every piezoceramic material has its own natural

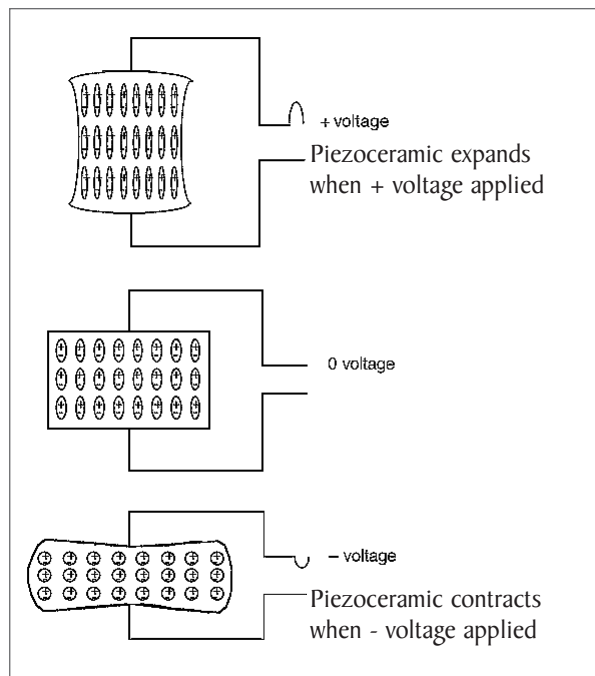

resonant frequencies. The size, shape, and thickness of the piezoceramic element determine the frequency at which it will vibrate best. Engineers very carefully control these factors to produce transducers that resonate at the correct frequency to meet the customers' needs.

Most of the piezoceramic elements that Airmar uses are thickness resonant. The thickness dimension of the piezoceramic element, rather than its diameter or shape, determines the resonant frequency.

A transducer can be designed with one piezoceramic that operates at two frequencies. Our popular 50/200 kHz transducer houses a piezoceramic element that can vibrate efficiently at two separate frequencies. It resonates at 200 kHz in the thickness mode and at 50 kHz across its

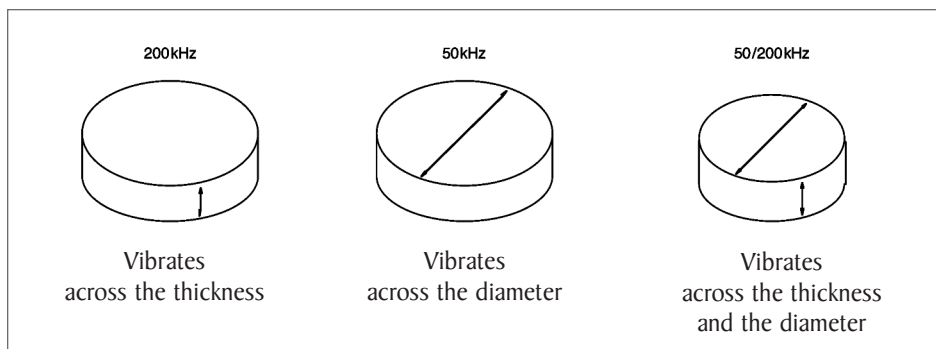

diameter which is called the radial mode. A transducer that can operate at two frequencies will have the characteristics of both frequencies—the ability to “see” well in both shallow and deep water with good bottom definition.

### What is capacitance?

Capacitance comes from the word capacity. It is the ability of a material to store an electrical charge. Piezoceramic elements are first class capacitors, able to hold a large electrical charge. In fact, the larger the piezoceramic the larger the charge that can be stored.

Knowing that piezoceramic elements store a charge and

that even slight cooling and heating will build-up an electrical charge, means that all piezoceramics must be handled with great care. Production workers must always short a piezoceramic before handling it. If this is not done, the piezoceramic may discharge, damaging other components in a multi-sensor transducer or even giving the handler a very nasty, albeit harmless, shock.

In spite of the precautions that need to be taken with

piezoceramics, their ability to store an electrical charge can be used to our advantage. With a simple capacitance meter, we can test the piezoceramic after wires have been soldered in place and the cable has been attached. If a wire connection is faulty, only a small capacitance will show on the capacitance meter. A much larger capacitance will show if the piezoceramic is wired properly. This is an easy check of the manufacturing process.

## Sound Waves

### How do the sound waves travel in the water?

Understanding wave motion can help you understand the way in which transducers work. When you throw a pebble into still water, you can see small ripples or waves form around the spot where the pebble entered the water. If you watch closely, you will see these circular ripples or waves move evenly away from the center. When waves move in this manner, they are said to move in concentric circles.

When sound waves are transmitted, they too begin to spread out as they make their way deeper into the water. Because the sound waves have been transmitted under the boat, they are moving downward and outward in concentric circles. Since the downward and outward movement is happening at the same time, the waves are actually making a cone shape. This is referred to as the radiation pattern. Thinking of the sound waves transmitted from a transducer as an ice cream cone turned up side down will help visualize the sound field for a typical single-ceramic transducer.

### How wide is the radiation pattern made by a transducer?

We refer to the widest part of the cone-shaped radiation pattern as the beamwidth. It is the diameter of the outer most circle of sound waves. Engineers are able to increase or decrease the beamwidth and therefore the area that the transducer can "see".

One way to change the beamwidth is to use piezoceramic elements of different diameters. The larger the piezoceramic, the smaller and more concentrated is the sound beam; the smaller the piezoceram-

ic, the wider and less concentrated is the sound beam. For example, the beamwidth produced by the smaller, one inch, piezoceramic will "see" fish over a large area, whereas a larger, two inch, piezoceramic will provide a narrower beamwidth giving better bottom definition and detection of small fish in shallow water.

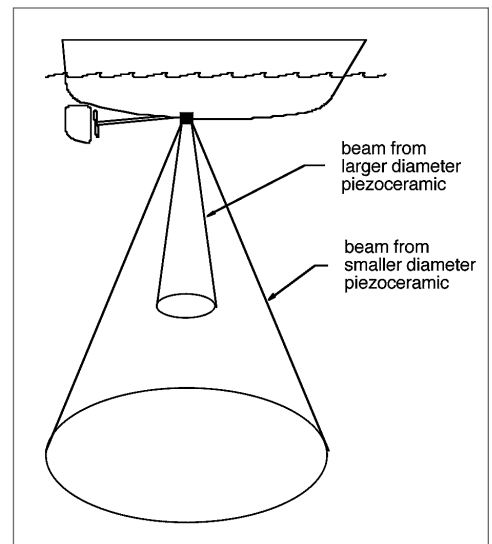

### How much underwater area can be seen by an echosounder?

Engineers determine how wide an area will be seen on the water's bottom by knowing the depth of the water and the transducer's cone angle. If you have a mathematical calculator or trigonometry tables, you can calculate beamwidth using the following formula:

$$(2 \times \text{depth}) \times (\text{tangent of } 1/2 \text{ cone angle}) = \text{diameter of the beam (beamwidth)}$$

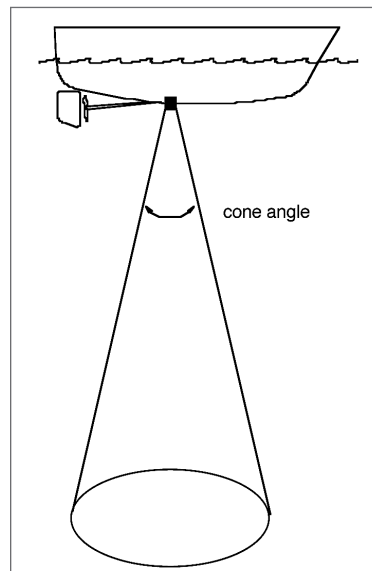

The chart on the bottom of this page shows this concept. There are several ways to specify beamwidth. The commercial fishing and naval industry frequently provide beamwidth information by measuring the sound beam at  $-3$  dB. The marine recreation industry, however, provides beamwidth information measured at  $-6$  dB, giving the impression that their transducers have a wider beam field.

## What is target masking?

There are areas within the transducer's range which seem to be invisible to the echosounder. This is known as target masking. It can happen if the lake or sea bottom drops off suddenly or contains a large rock. The sound waves will bounce off all of the sea bottom within the sound beam and return as strong echoes. The echoes from the highest point, the rock or drop-off, return to the transducer first, falsely indicating the apparent depth of the bottom. Small fish below the highest point will produce relatively small echoes which will return after the larger ones. Therefore, fish can be swimming around the sides of a large rock or a drop-off, be in the sound field, and yet remain invisible to the echosounder.

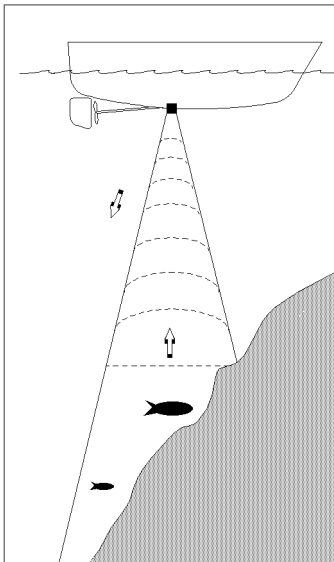

## What are sidelobes?

Our engineers are concerned about a phenomenon called sidelobes. You can see sidelobes for yourself by using a flashlight. If you shine a flashlight against a wall, you will see an area at the center where most of light is concentrated. Around the edge of the flashlight beam,

the rings of light will be dimmer. These rings are the sidelobes of the flashlight beam.

When engineers design transducers, they calculate what sidelobes are present. In fact, 60% to 70% of the sound waves will be concentrated in the cone area and the remaining waves will escape in all directions.

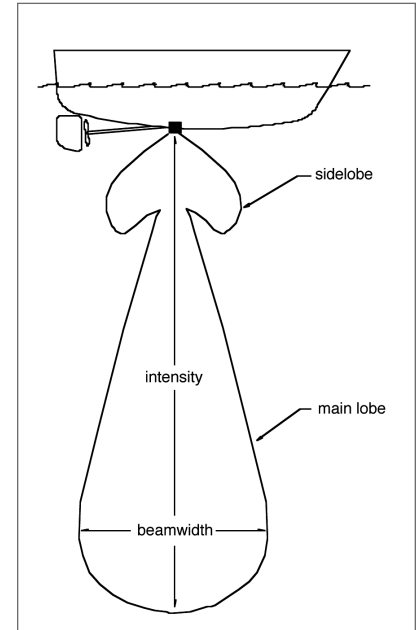

Engineers generally like to minimize sidelobes, although they may actually be desirable in some situations. As with a flashlight, a transducer does not "see" as well in the sidelobes, because fewer of the sound wave echoes return to the transducer. Fish might be present in this area, but a fisher would be unaware of them. However, in the case of a narrow beam transducer, sidelobes can be useful, since they effectively widen the coverage.

Sidelobes are typically presented as part of the transducer's radiation pattern. The lower, smaller, and narrower the sidelobes, the better the transducer performs, because more of the sound waves are focused in the main beam. Sidelobes are watched carefully during product development. Each transducer model creates its own particular sidelobe pattern as the sound waves travel through the water. This information is very important to those who design the echosounders to be used with our transducers.

## Diameter of Viewable Area or Beamwidth

Depth in Feet	Cone Angle						
	9°	16°	18°	20°	32°	45°	53°
5	0.8	1.4	1.6	1.7	2.8	3.9	4.6
10	1.6	2.8	3.1	3.5	5.6	7.9	9.2
25	3.9	7.0	7.9	8.7	14.0	19.6	23.1
35	5.5	9.8	11.0	12.2	19.5	27.5	32.4
50	7.9	14.0	15.7	17.4	27.9	39.3	46.2

## The Structure Of Transducers

### What goes into the making of a transducer?

It is clear that the transducer would not work without the piezoceramic element, however, other parts are also needed. A transducer is made up of six separate components:

- Piezoceramic element or an array of elements
- Housing
- Acoustic window
- Encapsulating material
- Sound absorbing material
- Cable

### What is the housing of a transducer?

The housing is the container that covers, protects, and supports the component parts of the transducer. The piezoceramic element is very brittle, and the wire connections to the piezoceramic are fragile. Because of this, the housing needs to be sturdy as well as resistant to the chemical, mechanical, and electrical forces in the environment where it will be used.

Our housings are made of a variety of materials and take on different shapes depending upon the customer's need and intended type of installation. Some of the housing materials are:

- Molded plastic
- Stainless steel
- Bronze
- Urethane (SEALCAST™)

The plastic and urethane housings are produced in our own molding department. Airmar's custom SEALCAST™ transducers feature a seamless housing and a compression fitting at the cable exit. This compression fitting secures the flexible cable at the point of attachment to the housing

and provides a water-tight seal to minimize any possibility of water entering the unit.

### What is an acoustic window?

The acoustic window is the surface through which the sound waves travel. It occupies the space between the piezoceramic assembly and the water. Any material used to create the acoustic window will absorb some of the sound waves that pass through it. Therefore, engineers carefully choose the least absorbent materials. The acoustic window is sometimes referred to as the acoustic face.

Epoxy, plastic, and urethane are the three materials Airmar uses most often for our acoustic windows. These materials have sound wave carrying capabilities or acoustic properties between those of the piezoceramic element and water.

### Acoustic window materials fall into two categories.

Soft, rubbery, elastic materials like urethane carry sound waves in almost the same manner as water. So, water and urethane are said to have similar acoustic properties. Because of this close match, the thickness of acoustic windows made from urethane does not need to be tightly controlled in our product designs.

Hard materials like plastic and epoxy have acoustic properties somewhere between those of piezoceramic elements

and water. In other words, the plastic or epoxy acts like an intermediate acoustic step between the fluid water and the rigid piezoceramic element.

A plastic or epoxy acoustic window is called a matching layer. Layer thicknesses are carefully calculated and produced to match the sound wavelength at the operating frequency.

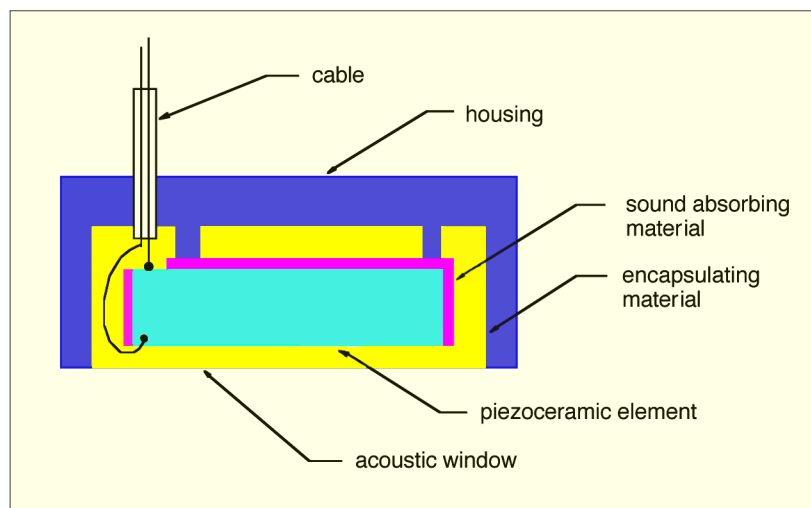

## How will air bubbles interfere with transducer function?

Because air is much less dense than water, air bubbles scatter and reflect sound waves. Any air bubbles in the acoustic window material or in the water will interfere with the proper working of the transducer, greatly reducing its performance. To minimize the chance for tiny, fleck-like, micro-bubbles in the acoustic window material, it is placed under a vacuum for a specific amount of time.

Air bubbles must, also, be carefully guarded against by the installer and user. If the transducer is glued to the inside of the hull of a boat, even the glue cannot have air bubbles in it. Indeed, a transducer needs to be placed away from anything, including the propeller, that will cause air bubbles to form while the boat is underway.

## What will interfere with an acoustic window's ability to become wet?

In order for a transducer to work correctly, the surface of the acoustic window must be thoroughly wet. How quickly the acoustic window becomes wet depends, in part, upon the type of material used to make it.

Glossy surfaces, such as our plastic and SEALCAST™ urethane acoustic windows, wet almost instantly, because they are smooth.

Our sanded urethane acoustic windows take much longer to become thor-

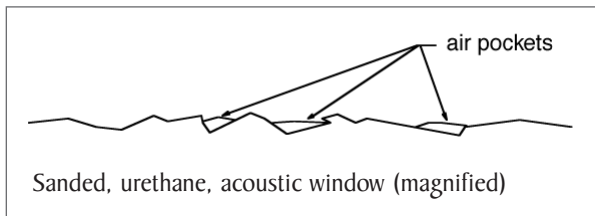

oughly wet. Although the sanded urethane does not seem rough to the touch, the sanding process leaves microscopic peaks and valleys which trap air bubbles keeping the water from touching the urethane.

Because of this, transducers with sanded urethane acoustic windows would have to soak in water for a minimum of one hour before testing their ability to transmit and receive. In order to shorten this process, our testers lightly scrub the urethane window with alcohol in order to hasten the wetting process. Both the scrubbing and the alcohol help to quickly displace the microscopic air bubbles.

## In what other ways do acoustic windows differ?

Acoustic windows can be “hard” or “soft.” Soft acoustic windows made of urethane provide excellent sensitivity to echoing sound waves, therefore soft windows can “read” through deeper water with better clarity of detail. This material is extremely stable in water, therefore providing excellent reliability for years. Because the acoustic properties of urethane are similar to water, the acoustic window can be made in the shape of a dome, wedge, or an arc.

Hard plastic and epoxy acoustic windows are especially good for boats that are trailered or often in and out of the water, because these windows become wet quickly. They also have characteristics which are good in shallow water and in fishfinding.

## What is the encapsulant?

The encapsulant is the material that encases the parts of the transducer within the housing. It can act as an acoustic window material, filler, or sealant. At Airmar the encapsulant is often called potting material and includes epoxies and urethanes. The choice is based upon its ability to meet the performance and application requirements of the particular transducer design.

## What is sound absorbing material?

Sound absorbing material is any material that interrupts or stops the flow of sound waves. In our case, it is the material used to dampen any unwanted vibrations of the piezoceramic element

in a transducer.

When AC voltage is applied to a piezoceramic element, all surfaces of the element vibrate. This means it sends off or radiates sound waves in all directions. Therefore, the piezoceramic element could pick-up echoes returning from all directions giving false information to the echosounder. This effect is called spurious radiation and must be avoided.

To reduce spurious radiation as much as possible, the piezoceramic element is surrounded with sound absorbing material, usually a layer of cork or foam. In this way vibrations of the piezoceramic element are dampened on all the surfaces except the surface facing the acoustic win-

dow. As a result, the sound waves are given directionality. They are concentrated in one direction only. Directionality is also effected by the piezoceramic's shape and frequency.

## How do Airmar cables function?

A transducer cable is the vehicle which carries the electrical current between the echosounder and the transducer. It is usually made of several conductors or wires. Cables are carefully engineered to carry a specified voltage and current from the echosounder to the sensor(s) in the transducer.

Inside the jacket of each cable is shielding to protect against electrical pulses from other electrical equipment that could interfere in the workings of the transducer. This interference is called electrical noise. Commonly heard as static, electrical noise could come from a ship-to-shore radio, navigation equipment, ignition impulses, or even another transducer. Interference has the same effect on the echosounder display screen as it does on a television screen; the picture becomes

snowy—the clarity and sharpness of the image is lost.

Depending upon the application and performance requirements for the transducer, several types of shielding are used such as:

- Aluminum foil on Mylar
- Tinned braided shield
- Spiral shield

The cables outer jacket protects the inner conductors and provides strength and flexibility.

Jackets materials include:

- PVC—polyvinyl chloride
- TPR—thermoplastic rubber
- Neoprene
- Polyurethane

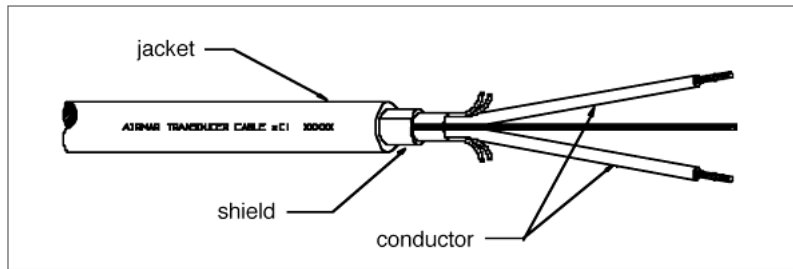

## Performance Testing

### What is performance testing?

Airmar products are designed to a customer's specifications or to fill a market need. Engineers most often begin with a required frequency and cone angle. After the transducer is designed, a sample is built in the lab where it is extensively tested. Data is collected on:

- Frequency
- Beamwidth
- Transmitting Voltage Response (TVR)
- Receiving Voltage Response (RVR)
- Figure-of-Merit
- "Q" (Bandwidth)
- Ringing
- Impedance

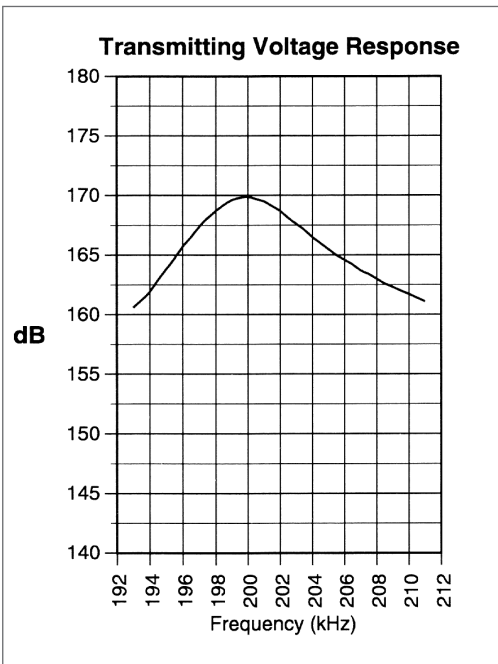

This information is known as performance data which is made available to customers and used as the standard for final testing of the product. The figures are extremely important to our OEMs as this data is used to determine the frequency at which the echosounder must be set.

Airmar products are tested many times during their manufacture and are subjected to a careful final inspection. A wide variety of test equipment, including our test tanks, is used.

## What are the Transmitting Voltage Response and the Receiving Voltage Response?

Each Airmar transducer model is tested to measure the strength of the transmitted sound wave and the received sound wave (what we have been calling the echo).

The Transmitting Voltage Response (TVR) is a measure of the acoustic pressure of the sound wave at a distance of one meter when one volt of electricity is applied to the transducer. If we could hear the sound waves, we might say the TVR is an indication of how loud a sound the transducer produces when one volt is applied to it.

The Receiving Voltage Response (RVR) is a measure of the voltage produced within the transducer when a 1 mPa (micropascal) of acoustic pressure is received. An mPa is a unit for measuring sound pressure. The pressure of the echoing sound waves causes the piezoceramic to produce voltage, the RVR. Think of a lamp that can be turned on by the clap of hands. It is the loudness of the clap, the pressure of the sound wave, that turns on the lamp. If we could see the transducer's response to the echoing sound waves, we might say the RVR is an indicator of how brightly the lamp shines.

Comparing the TVR and RVR shows that the difference between the actual voltage used for transmitting and the actual voltage generated by the returning echo is tremendous. Sound waves are emitted by voltage measuring in the hundreds (100s) of volts, yet the returning echoes are measured in hundredths (1/100s) of a volt.

## What is the Figure-of-Merit?

The Figure-of-Merit is a measure of how well a transducer works when used for both transmitting and, then, receiving its own echoes. It is the algebraic sum of the Transmitting Voltage Response and the Receiving Voltage Response. The Figure-of-Merit is sometimes referred to as the Insertion Loss.

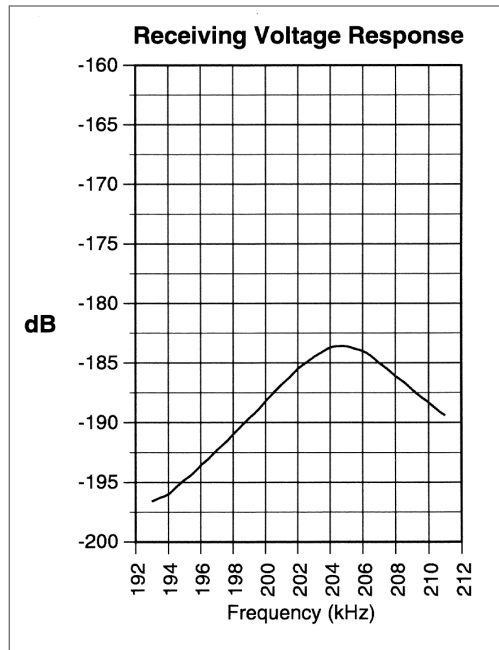

As we know from the Receiving Voltage Response, the returning sound wave will be far weaker than the original sound wave that was sent out. This is because the transmitted sound wave loses energy by the time it travels through the water, bounces, and returns.

Engineers test each transducer model and graph the results of the Transmitting Voltage Response, the Receiving Voltage Response, and the Figure-of-Merit. The graphed curve of the Figure-of-Merit will usually peak somewhere between the peak of the Transmitting Voltage Response and the peak of the Receiving Voltage Response.

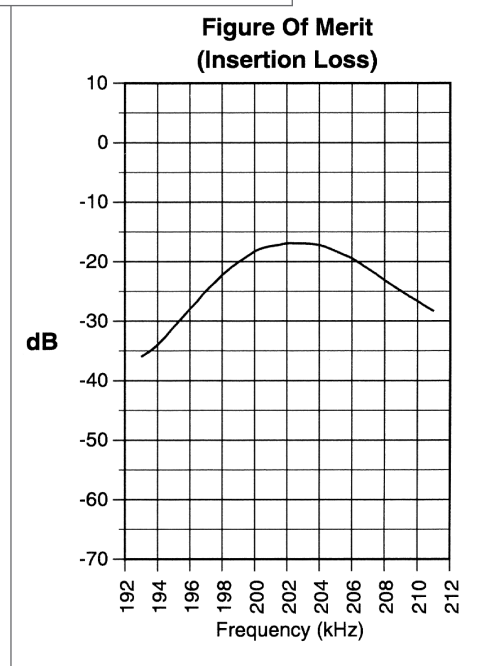

## What is "Q"?

"Q" stands for quality and is a measure of the sharpness of the response of the piezoceramic element to the frequency that is supplied to it. In other words, "Q" describes how precisely the frequency must be output to achieve the best performance from

the transducer. It answers the questions: "What is the piezoceramic element's best or resonant frequency?", "How well does the piezoceramic element work on either side of its resonant frequency?", and "How long will the transducer continue to ring after a transmit pulse?"

Engineers have a standard method for determining "Q". It is the operating frequency divided by the bandwidth. For non-engineers, it is helpful to think of frequency and bandwidth in terms of volume and tuning-in your favorite

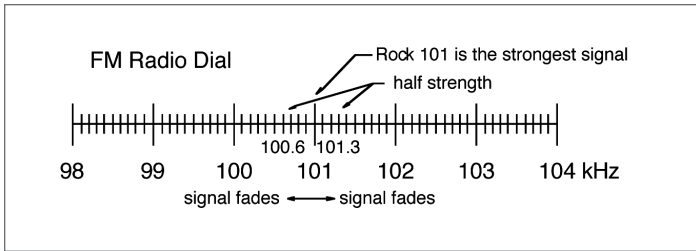

radio station. The operating frequency is that spot on the radio dial where your favorite station comes in the loudest and clearest.

The bandwidth includes the frequencies slightly above and below the best spot, but where the station can still be heard. Engineers use the standard of three decibels below the peak Transmitting Voltage Response, shown as -3 dB. If we could hear the transducer sound waves, the -3 dB point is where the sound would be half as loud. As we turn the dial above and below our station, the signal begins to fade, so we can't hear it as well. The points above and below the radio station on the dial at which our radio is half the

volume of the correct radio station frequency determines our bandwidth.

The "Q" of a transducer model can be determined by analyzing its Transmitting Voltage Response graph. The resonant frequency and peak TVR is at 50 kHz. At 3 dB below TVR, the frequencies are 47.6 kHz and 52.8 kHz, giving us a bandwidth of 5.2 kHz (52.8 kHz - 47.6 kHz = 5.2 kHz). To determine "Q",

the resonant frequency is divided by the bandwidth giving us a "Q" factor of 9.6. (50 kHz ÷ 5.2 kHz = 9.6).

"Q" factors range between 1 and 40. At 9.6 this model's "Q" factor is relatively low. The OEM need not be as precise in setting the echosounder's drive frequency when a transducer has a lower "Q".

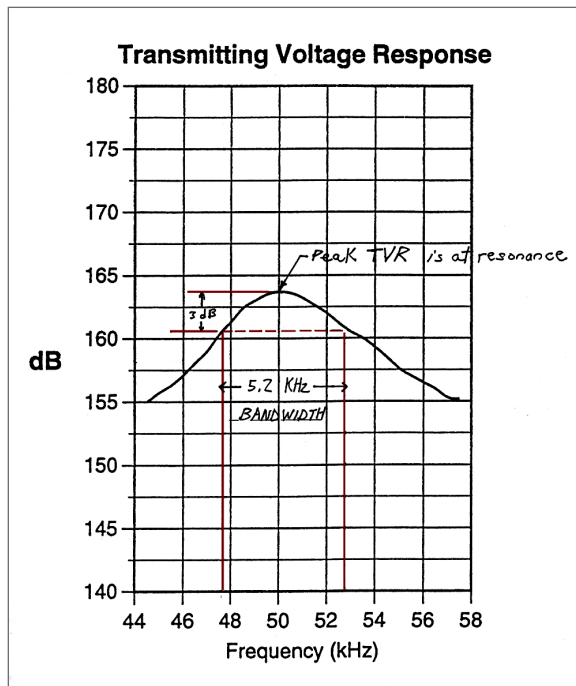

## What is Ringing?

Ringling is the continued vibration of the piezoceramic element after each transmit pulse. Imagine the ringing of a large church bell. After the church bell is struck by the clapper, it continues to ring for a time if the vibrations are not dampened.

This phenomenon also occurs in piezoceramic elements. The vibrations of the element continue after the transmit pulse. These vibrations decrease in amplitude (or "loudness" if we could hear them) just as the ring of the church bell gets softer over time. The tapering off of the vibrations is called the ring down.

In effect, ringing causes a "stretching" of the transmit pulse, because it generates unnecessary sound waves. These additional sound waves add additional microseconds to the dead band, interfering with the reception of echoes.

If a desired echo arrives during the ring down it will appear on the echosounder screen as a smear or it may even be hidden by the ring down and not appear on the echosounder screen at all. Ringing, therefore, reduces the clarity of the display on the echosounder screen.

Ringdown also keeps the transducer from "seeing" in very shallow water.

Ringling can never be totally eliminated. With the proper engineering, however, it can be greatly reduced. A transducer with a high "Q" factor is one which will ring for a long time after being struck with a transmit pulse. Conversely, a low "Q" transducer exhibits less ringing.

## How are the deadband and blanking zone related?

As you have learned, during the transmit pulse the piezoceramic is vibrating, so no echoes can be received—in the same way that you cannot listen when you are talking. The microseconds when the transducer is transmitting is the deadband for the reception of echoes.

When something very close to the transducer (usually between one and three feet), the bouncing echoes will

return before the piezoceramic has stopped ringing. Since the echo is in the deadband, these echoes cannot be received—the object will be invisible. The minimum distance between the transducer housing and an object that can be “seen” is called the blanking zone. OEMs typically want a small blanking zone, so their echosounders can “see” objects close to the transducer.

## What is Impedance?

Impedance stems from the word impede and means something that hinders progress. In the field of electricity, it refers to the limitation of the amount of current that can flow through a material. Impedance is technically the ratio of voltage to current. Airmar measures the amount of electrical force applied to the transducer and the amount of current that actually runs through the transducer. The

quotient is the impedance.

The echosounder must be designed to match the impedance of the transducer to deliver the correct power to it. If they do not match, the output from the transducer will be reduced lessening the performance of the entire system.

Airmar chooses materials that are natural conductors of electricity. Silver is used on our piezoceramic elements, because it is an excellent conductor and is easy to apply and bake onto our piezoceramic elements. Copper is used in all electric wiring, because it is an excellent conductor and less expensive than silver.

Some materials will not allow electrons to flow through them at all. These materials are called insulators. They are used around all electrical wires to keep electricity flowing through the conductor(s) and prevent electricity from flowing elsewhere.

## Airmar Products

### How are Airmar products unique?

Airmar’s products incorporate the most advanced technology; often pioneered by Airmar. Our attention to detail makes our sensors more accurate and reliable than the competition. Careful design, manufacture, and testing insures that our transducers perform to specifications. We use waterproof connectors, multiple O-rings, seamless construction, and strong materials to produce sensors that can withstand harsh environments.

### What products does Airmar manufacture in each product line?

**Recreational Sensors**—Our recreational transducers can be manufactured to perform several different functions when used with the appropriate information display unit.

Airmar sensors can measure:

- Temperature only
- Depth only
- Depth with Speed
- Depth with Temperature

- Depth with Speed and Temperature (TRIDUCER® multisensor)
- Speed only
- Speed with Temperature

Recreational transducer housings come in several shapes depending upon their intended method of installation.

**In-hull**—This transducer is installed against the inside of a boat hull bottom and sends its signal through the hull. Some people prefer this method, because the unit cannot be damaged when the boat is trailered. Also, drilling through the hull is not necessary. In-hull transducers can work better than other models at high boat speeds.

Because in-hull units “shoot” through the layers of the hull, there is a loss in performance. In addition, this installation will not work on a boat made of any material containing air bubbles, because the air bubbles reflect and scatter the sound before it reaches the water. Wooden hulls and fiberglass hulls with foam, balsa wood, or plywood layers sandwiched between the inner and outer skins are not recommended for in-hull installation.

**Transom Mount**—This transducer style is mounted to the back (transom) of a boat hull. Some people prefer this style, because it affords easy

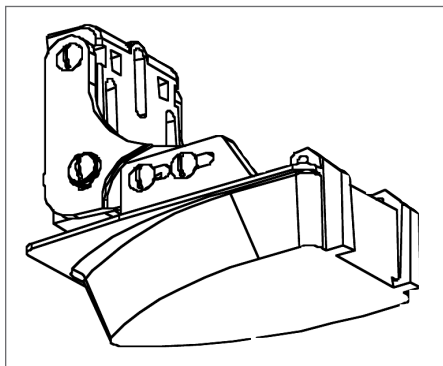

installation and removal of the unit—especially if a kick-up bracket is used. A kick-up bracket allows the transducer to be moved out of the way to prevent damage from a boat trailer. A transom mount installation gives better performance than the in-hull installation at boat speeds up to 30 MPH.

**Thru-hull**—This transducer is installed through a hole in the boat and protrudes into the water. It is most often used on boats 25 feet or longer and usually provides the best performance. The transducer is low enough in the water to avoid most of the air bubbles caused by the motion of waves.

Thru-hull units are not recommended in two situations:

- Plastic thru-hull housings should not be used on a wooden boat. Wood swells as it absorbs water, so it may crack the housing.
- Bronze thru-hull housings should not be used in aluminum boats. The interaction between the aluminum and the bronze especially in the presence of salt water, will eat away the aluminum hull and/or bronze housing.

## Temperature Sensors

Temperature sensors are desirable for several reasons. Anglers know that fish prefer certain water temperatures, so a temperature sensor can help the fisher determine where the fish may be hovering. Boaters may wish to know the water temperature before jumping in for a swim, but more importantly, it can be a navigational aid. For example, the water in the Gulf Stream is much warmer than the surrounding Atlantic Ocean. Boats traveling north are wise to locate and ride the current while those traveling south need to avoid the Gulf Stream entirely.

Temperature is most commonly read by a temperature sensor called a thermistor. The Airmar thermistor is a 10,000 ohm resistor which varies in value according to its temperature. This means that the amount of electricity flowing through the resistor is directly related to the temperature of the resistor. The warmer the resistor the more electricity is able to flow through it. Conversely, less current is able to flow through the resistor when it is cold. The amount of electrical current flowing through the resistor, therefore, tells us the temperature of the water.

Most of Airmar's temperature sensing devices are built right into the transducer housing.

In our bronze transducer the temperature sensor is placed inside the housing cavity because the metal housing itself is a good thermal conductor. The bronze quickly takes on the temperature of the water and, as a result, the temperature sensor doesn't require direct water contact.

In a few other types of transducers a semiconductor temperature sensor is also used. Because the electrical voltage put out by the semiconductor changes slightly with each degree of temperature, the temperature of the water can be determined by measuring the electrical voltage put out by the semiconductor.

## Speed Sensors

Boat speed is measured in nautical miles per hour called knots. A nautical mile is 6,076 feet, approximately 1.15 land miles.

The component used to determine boat speed is called a Hall Cell and works like an on/off switch. Within the sensor are magnetic parts that can be turned on and off by a passing magnet. The Airmar paddlewheel blades are magnetized. As the boat moves through the water, the paddlewheel turns. Each time a magnetized blade of the paddlewheel passes by the Hall Cell, it is turned on or off, creating a pulse of electricity. Electronics in the echosounder system count the frequency of these pulses, then convert them into knots. A paddlewheel may create as many as 22,000 electrical pulses per nautical mile.

## TRIDUCER® Multisensor

The Airmar TRIDUCER® multisensor is a combination of three sensing devices built into one housing to measure depth, speed, and temperature.

## Phased Array Transducer

A phased array transducer can function as both a downward looking and a forward looking transducer. It does not point straight down only. Rather, the echosounder can steer the beam about 45 degrees to either side. These transducers are able to "see" both the immediate underwater depths and what is ahead of the boat. It can see both a large schools of fish toward which a boater would like to steer and large objects or a shallowing bottom to be avoided.

## Commercial Fishing Transducers

These transducers are available in frequencies from 24 kHz to 200 kHz. Units feature high-efficiency designs producing superior fish finding and clear and distinct images of both the bottom and closely spaced fish.

## Navigation and Ocean Survey Transducers

This broad product group features transducers ranging from 10 kHz to 2 MHz. Airmar offers transducers sized from small portable units for harbor survey to multi-frequency arrays for deep sea sounding. Arrays of more than 100 piezoceramic elements have been designed and manufactured by Airmar. We can produce dual beam and split beam transducers and linear phased, and multi-beam transducer arrays.

One hydrographic product specifically designed for a customer is the Swath bathymetry transducer. Its transmitting transducer uses a fan beam which is very narrow in one direction and very broad in the other direction. Echoes are received by 30 separate transducer elements which form 30 separate beams. This provides 30 sets of data yielding a great amount of detail about the bottom. One Swath is used to monitor the ever shifting channels in the Mississippi River.

## dB PLUS II™ Acoustic Deterrent System

The dB PLUS II™ Acoustic Deterrent System uses Airmar's skill at producing sound waves, to scare away marine life rather than to find it. Our popular acoustic deterrent system is designed to protect fish farms from seals and other marine predators who find the fish an inviting target.

The acoustic deterrent system has a series of four transducers positioned around the fish pens which are made of net. The transducers work as projectors only, giving out sound waves for 2.5 seconds in turn. It takes 18 seconds to complete one full four-transducer transmission cycle. The amplifier for creating the electrical power supplied to the transducers is centrally located among the net pens.

Research tells us a sound wave frequency of 10 kHz is not harmful to seals, but it is definitely irritating. Their desire to get away from the sound overcomes their desire for an

easy meal. The sound has been likened to the scratching of fingernails on a blackboard.

The **dB PLUS II™** Acoustic Deterrent System has a unique "soft-start" feature. The system takes 25 seconds to reach full power. This gradual sound increase provides a warning to divers and allows seals and sea lions the option of leaving the area before the sound reaches its highest volume.

This product has been successfully used in waters off of the U.S., Canada, Chile, New Zealand, and Europe. The seals are keeping their distance, so the customers are very happy.

## Air Transducers

Air transducers work in a way that is very similar to marine transducers. Air, however, is not as good a conductor of sound waves as water. In fact, sound travels only 25% as fast in air as in water. Think of the time delay between seeing lightning and hearing the thunder or between your shout and its echo. Speed is not the determining factor in the loss of efficiency. Temperature, humidity, and wind are the determining factors.

Air transducers can be used in a variety of ways in both commercial and industrial applications:

- Silo or tank level detection of liquids such as oil; or of solids such as grain, coal, flour, or anything stored in bulk
- Proximity measurement
- Process control
- Object detection
- Volume of liquid flow through weirs
- Sensing through foams
- Level detection in waters with sediment such as septic plants or in environments that are dusty
- Liquid column measurement

## What are the characteristics of air transducers?

Frequencies from 25 kHz to 225 kHz are available in our air transducers.

Airmar's models are designed to meet criteria set by hazardous environmental certification agencies. Because air

has relatively low density, air transducers are susceptible to ringing. The dead band specification is very important to the OEMs and our engineers strive to design air transducers with low “Q” and, therefore, low ringing.

## Parts and Accessories

### What is a Fairing?

A fairing is a structure which is added to the transducer at the mounting location to improve its performance. If the hull slopes, a fairing orients the transducer so the sound beam will aim straight down. The chance of water with air bubbles flowing across the acoustic window is reduced by mounting the transducer deeper in the water. Also, Airmar carefully designs the shape its fairings to direct

water around the transducer, so that drag on the boat is minimized. All Airmar fairings are made from a polymer resin which will not swell or rot.

Our parts and accessory line includes:

- Housings, hull nuts, and cap nuts
- Switch boxes
- Mounting kits
- Cables and connectors
- Speed sensor parts
- Fairings
- Diplexer

## Glossary of Terms

**AC** the abbreviation for Alternating Current. Electrical current that reverses direction at regular intervals.

**AC voltage** used to cause the piezoelectric element to vibrate.

**Acoustic** relating to sound and sound waves.

**Acoustic Energy** when work can be done because energy is provided by the physical pressure of a sound wave.

**Acoustic Face** see Acoustic Window

**Acoustic Property** the ability of a material to carry sound waves through it.

**Acoustic Window** that part of the transducer through which the ultrasonic vibrations from the piezoceramic assembly travel to the water or other transporting medium. It occupies the space between the piezoceramic assembly and the water.

**Air Bladder** an organ in a fish which allows it to adjust easily to changes in water pressure at different depths. It is the organ that allows the echosounder to detect the fish.

**Amplitude** the degree of intensity (pressure) of a sound wave. If we could hear the sound wave, the amplitude would be its “loudness.”

**Angler** a person who fishes.

**Application Requirement** the use that the sensor is designed for.

**Array** a series of piezoceramic elements in a transducer.

**Bandwidth** the range of frequencies over which the transmitting sensitivity (TVR) is no less than one half of the peak sensitivity at -3dB.

**Beamwidth** the diameter of the circle in which 50% to 70% of the sound waves emitted by a transducer are concentrated.

**Cable** the wire that carries power between the echosounder and the transducer. It is usually constructed of several conductors.

**Capacitance** the ability to store an electrical charge.

**Ceramic** a commonly used name for the piezoceramic element.

**Concentric Circles** a series of circles of different sizes having a common center.

**Conductor** anything that carries electrical current. This may be a copper wire or any other material that readily allows electrons to pass through it.

**Cone Angle** the measurement of beamwidth in degrees. It is an indication of how large an area is covered by a transducer's sound beam. The larger the cone angle the larger the area covered.

**Current** the measure of the number of electrons that flow past a point in a specific unit of time.

**dB** an abbreviation for decibel. A unit for measuring the power of a sound wave.

**Deadband** the time during and immediately after a transmit pulse when a transducer cannot receive echoing sound waves and therefore cannot “see” the area below the surface of the water.

**Deadzone** the minimum distance between the transducer housing and an object that can be “seen” by an echosounder.

**Directionality** the controlled emission of sound waves in the desired direction.

**Display Screen** the part of the echosounder unit on which an image of the underwater area is projected.

**Drag** the retarding force exerted on a moving object.

# Glossary of Terms

**Echosounder** an instrument comprised of a display screen and electronic circuitry. It provides necessary power to the transducer, interprets the information received from the transducer, and displays this information in a readable format.

**Echosounder System** a system comprised of two major components—an echosounder and a transducer. This system measures the depth of the water and the distance to any objects in its field of vision, and displays this information in a readable format.

**Electrical Energy** when work can be done because energy is provided by an electrical force.

**Electrical Noise** interference in an electronic signal, often called static.

**Electrode** a solid material which conducts electricity and is used at the point where electrical current enters or leaves an object.

**Encapsulant** the material that acts as a filler in and around the transducer parts within the housing. It may also function as an acoustic window or a sealant. Encapsulant is often called potting material.

**Energy** a measure of a system's ability to do work.

**Figure-of-Merit (FOM)** the algebraic sum of the Transmitting Voltage Response and the Receiving Voltage Response. The Figure-of-Merit usually indicates a net loss of energy, and is sometimes referred to as Insertion Loss.

**Frequency** the number of complete cycles or vibrations that occur within a specific time frame, typically one second. It is usually measured in Hertz.

**Hall Cell** a wafer of silicon altered by electrical current so that it responds magnetically.

**Hertz (Hz)** a measure of one cycle or complete vibration per second.

**Housing** something that covers, supports, or protects the mechanical parts.

**Impedance** the limitation of the amount of flow of electrical current. It is commonly used as a comparison between the amount of voltage needed to get a specific amount of current.

**In-hull Installation** the method of installing a transducer by attaching it to the inside of the hull.

**Injection Molding the** process of creating parts by forcing melted material (usually plastic) into a mold in the desired shape. The material is then cooled and released from the mold.

**Insertion Loss** the algebraic sum of the Transmitting Voltage Response and the Receiving Voltage Response. This usually indicates a net loss of energy. Often referred to as the Figure-of-Merit.

**Insulator** any material that will not allow electrons to pass through. These materials are used to surround conductors to keep the current flowing in the desired direction.

**Jacket** the covering that surrounds a cable and provides strength.

**Kilo-Hertz (kHz)** one thousand cycles or complete vibrations of sound per second.

**Knots** nautical miles per hour. A nautical mile is 6,076 feet or roughly 1.15 statute miles.

**Matching Layer** an acoustic window material like plastic or epoxy that has acoustic properties somewhere between those of the piezoceramic element and the water. It acts as an intermediate acoustic step and facilitates the travel of sound waves from the piezoceramic element to the water.

**Nautical Mile** 6,076 feet or 1.15 statute miles.

**Ohm** a unit of resistance to an electrical current. Some materials conduct electricity readily while others are poor conductors. The poorness of the conductivity is the resistance of the molecular structure to carrying the electrical current.

**Original Equipment Manufacturer (OEM)** These are the businesses that buy our product for use with their manufactured products.

**Performance Requirement** the work that a customer needs the transducer to do, e.g. see a narrow but deep area or measure speed and temperatures in salt water below 32° F.

**Personal Water Craft (PWC)** a jet-ski type recreational water vehicle.

**Phased Array** a series of piezoceramic elements in a transducer. The piezoceramic elements are wired in a manner which allows them to fire in time delayed sequence, so the echosounder can electronically steer the array.

**Piezoceramic Element** a material made of crystals with positive and negative charges. Frequently referred to as a piezoceramic or ceramic.

**Polarize** the ability to align electrically charged crystals placing like poles in the same direction.

**Pole** one end of polarized material, i.e. the positive pole of a piezoceramic element.

**Potting Material** see Encapsulant

**Projector** when the transducer acts as a transmitter only. This is the case with the dB PLUS™ II Acoustic Deterrent System.

**“Q”** an abbreviation for quality. A measure of how tolerant a transducer is to changes in frequency.

**Radiation Pattern** outline of sound waves as they travel outwards from a transducer, usually represented as a cone shape.

**Receiving Voltage Response (RVR)** the measure of the voltage produced within the transducer when returning echoes are received.

**Resistor** an electrical component used to limit the amount of an electrical current passing through it. The level of this limitation is measured in ohms.

## Glossary of Terms

**Resolution** the ability to show fine detail. Better resolution provides better discrimination among individual objects.

**Resonant** the natural tendency of a material to vibrate at its own favored rate (frequency).

**Ring Down** the tapering off of the vibrations from a transmit pulse. The vibrations may interfere with the reception of accurate information by the transducer and thereby distort the information displayed by the echosounder screen.

**Ringing** the continued vibration of a piezoceramic element beyond the electrical transmit pulse. This causes distorted information to be displayed on the echosounder screen.

**SEALCAST™** an Airmar trademarked name for a transducer housed in one seamless unit.

**Sensor** any device that detects and responds to a stimulus such as temperature, speed, motion, light, various chemicals, etc.

**Shielding** material used to prevent interference from other electrical equipment on the boat or in the area that could interfere with the workings of the transducer.

**Sidelobes** those portions of the acoustic signal that are located outside the main sound beam.

**Smear/Smearing** distorted information, specifically a running together of fish images displayed by the echosounder system because of unwanted sound waves.

**Sonar** derived from the words sound navigation ranging. An apparatus that uses reflected sound waves to detect and locate underwater objects.

**Sound Field** the total area where sound waves travel from a transmit pulse. The sound field includes the main beam and sidelobes as well as spurious radiation.

**Sound Isolating Material** usually a layer of cork or foam that surrounds the piezoceramic element except where it comes in contact with the acoustic window. This is done to focus the sound waves in one direction and prevent spurious radiation.

**Speed Sensor** a device that detects the rate of speed of a water craft.

**Spurious Radiation** sound waves that escape in non-desired directions. This produces false readings by the echosounder system.

**Target Masking** the areas within a transducer's range which seem to be invisible to the transducer.

**Temperature Sensor** a device that detects the temperature of water.

**Thermal Conductor** a material with the ability to let heat travel through it. A good thermal conductor adjusts quickly to the temperature of its environment.

**Thermistor** a unit for sensing and measuring temperature.

**Thru-hull Installation** a method for installing a transducer through a hole in the hull of a boat.

**Transducer** a device that changes electrical energy to acoustic energy and back again. This function is performed by a piezoceramic element(s).

**Transmit Pulse** a usually brief sequence of sound waves sent out by the transducer. Following the transmit pulse there is a longer period of time when the transducer stops transmitting and receives the echoes.

**Transmitting Voltage Response (TVR)** the pressure or "loudness" of a sound wave produced by one volt of electricity.

**Transom Mount Installation** a method for installing a transducer on the back (transom) of a boat hull.

**TRIDUCER® Multisensor** an Airmar trademarked name for a sensor that can measure three functions: depth, speed, and temperature in one unit. Airmar has been granted a patent for TRIDUCER® multisensors and has sole rights to this design.

**Ultrasonic** sound waves of high frequency than cannot be heard by humans. Sound waves higher than 20,000 Hertz.

**Volt** a unit of electrical force.

**Voltage** a measure of electrical force or the potential for current to flow.

**Work** the effect of force acting on a body. It is the relationship between the application of a force to an object and the distance that object moves when the force is applied. It is calculated by multiplying the force times the distance the object is moved.

**AIRMAR**  
TECHNOLOGY CORPORATION

35 Meadowbrook Drive, Milford, New Hampshire 03055  
Tel 603 -673-9570 ■ Fax 603-673-4624 ■ [www.airmar.com](http://www.airmar.com)